



BOSCH



Register your
new device on
MyBosch now and
get free benefits:
**[bosch-home.com/
welcome](https://bosch-home.com/welcome)**

Washing machine

WAP28481AU WAP28482AU

en Instruction Manual and Installation Instructions

Your new washing machine

You have chosen a Bosch washing machine.

Please take a few minutes to read and become familiar with the advantages of your washing machine.

To meet the high quality demands required by Bosch, every washing machine that leaves our factory is carefully checked to ensure that it functions correctly and is in perfect condition.

For more information on our products, accessories, replacement parts and services, see our website www.bosch-home.com or contact our after-sales service centres.

If the operating and installation instructions describe different models, any differences will be pointed out at the relevant points in the text.



Read these operating and installation instructions before switching on the washing machine.

Display rules

Warning!

This combination of symbol and signal word indicates a possibly dangerous situation. Not heeding the warning can cause death or injuries.

Caution!

This signal word indicates a possibly dangerous situation. Not heeding the caution can cause property and/or environmental damage.

Note/tip

Information about the optimum use of the appliance/any other useful information.

1. 2. 3. / a) b) c)

The steps are represented by numbers or letters.

■ / -

Lists are represented by a small box or a dash.

Contents

 Intended use	4	Select additional programme settings	16
 Safety instructions	5	Placing laundry into the drum	17
Electrical safety	5	Measure and add detergent and care products	17
Risk of injury	5	Starting the programme	18
Safety for children	5	Childproof lock	19
 Environmental protection	7	Adding/removing laundry	19
Packaging/used appliance	7	Changing the programme	19
Tips on economical use	7	Cancel the programme	20
 Getting to know the appliance .	8	Programme end during rinse hold. .	20
Washing machine	8	Programme end	20
Control panel	9	Removing laundry/switching off the appliance.	20
Display panel	10	 Setting the signal	21
 Laundry	11	 Sensors	21
Preparing the laundry	11	Automatic load sensing	21
Sorting laundry	11	Unbalanced load detection system .	21
Starching	12	 Cleaning and maintenance . . .	22
Dyeing/bleaching	12	Machine housing/control panel.	22
Soak	12	Drum	22
 Detergent	12	Descaling	22
Correct selection of detergent	12	Detergent drawer and housing	22
Saving energy and detergent	13	Detergent solution pump blocked	23
 Programme default settings . . .	13	The drain hose at the siphon is blocked	24
Temperature	13	Filter in the water supply is blocked .	24
Spin speed	13	 Faults and what to do about them	25
Finish in time	14	Emergency release	25
 Additional programme settings 15		Information on the display panel	26
SpeedPerfect/EcoPerfect	15	Faults and what to do about them.	27
Rinse&Water Plus	15	 After-sales service	29
Easy Iron.	15	 Technical information	29
 Operating the appliance	16	Technical data	29
Preparing the washing machine	16	Information for test institute	30
Select programme/switch on the appliance	16	 Positioning and connecting . . .	31
Change the programme default settings	16	Standard accessories	31

Safety instructions	32
Installation surface	32
Installation on a base or a wooden joist floor	32
Installation on a platform with drawer	32
Installing the appliance in a kitchenette	32
Removing the transport locks	33
Hose and cable lengths	33
Water inlet	34
Water outlet	35
Levelling	36
Electrical connection	36
Before washing for the first time	37
Transportation	37



Intended use

- For private domestic use only.
- The washing machine is suitable for washing machine-washable fabrics and hand-washable wool in detergent solution.
- To be operated with cold mains water and standard detergents and care products which are suitable for use in front-loading washing machines. Do not use detergents for hand wash.
- When measuring the amount of all detergents/additives/care products and cleaning agents, always check the manufacturer's instructions.
- The washing machine may be used by children over the age of 8 years old and by persons with reduced physical, sensory or mental capacity or by persons with a lack of experience or knowledge if they **are supervised** or have **been instructed** by a responsible person. Children must not perform cleaning or maintenance work unsupervised.
- Keep children under the age of 3 years away from the washing machine.
- This appliance is intended for use up to a maximum height of 4000 metres above sea level.
- Keep pets away from the washing machine.

Read the Instruction Manual and Installation Instructions and all other information supplied with the washing machine and use the machine accordingly.

Retain the documents for subsequent use.

Safety instructions

Electrical safety

Warning

Risk of death!

There is a risk of electric shock if you touch live components.

- Never touch or hold the mains plug with wet hands.
- Only pull out the mains cable by the plug and never by the cable, as this could damage it.
- The appliance must be grounded.
Electrical connection
→ Page 36

Risk of injury

Warning

Risk of injury!

- When the washing machine is lifted by its protruding parts (e.g. the washing machine door), the components may break off and cause injuries.
Do not lift the washing machine by protruding parts.
- If you climb on the washing machine, the worktop may break and cause injuries.
Do not climb onto the washing machine.

- If you lean on the washing machine door when it is open, the washing machine may tip over and cause injuries.
Do not lean on the washing machine door when it is open.
- Reaching into the drum when it is turning can cause injuries to hands.
Do not reach into the drum when it is turning.
Wait until the drum has stopped turning.

Warning

Risk of scalding!

When you are washing at high temperatures, there is a risk of scalding if you come into contact with hot water e.g. if hot water is being drained into a wash basin.
Do not reach into the hot detergent solution.

Safety for children

Warning

Danger of death!

- If children play with the washing machine, they may get into life-threatening situations or injure themselves.
- Do not leave children unattended near the washing machine.
 - Do not let children play with the washing machine.

 **Warning**

Danger of death!

Children may lock themselves in appliances, putting their lives at risk.

For appliances that have reached the end of their service life:

- Disconnect the mains plug.
- Cut through the mains cable and remove it, along with plug.
- Destroy the lock on the washing machine door.

 **Warning**

Risk of suffocation!

Children may become wrapped in packaging/film or packing parts if allowed to play with them, or they may pull them over their heads and suffocate. Keep packaging, film and packaging parts out of the reach of children.

 **Warning**

Risk of poisoning!

Detergents and care products may be poisonous if consumed.

Keep detergents and care products out of the reach of children.

 **Warning**

Eye/skin irritation!

Detergents and care products may cause irritation if they come into contact with the eyes or skin.

Keep detergents and care products out of the reach of children.

 **Warning**

Risk of injury!

When you wash at high temperatures, the glass in the washing machine door gets hot.

Do not let children touch the hot washing machine door.



Environmental protection

Packaging/used appliance



Dispose of packaging in an environmentally-responsible manner.

The following Do's and Don'ts provide a framework for the return and recycling of used products when available in your area.

Do's

- Hand over the old/discarded electronic equipment only to authorized collection centers for disposal
- Consult the authorized service center as to whether the Electronic Equipment can be repaired or not, before discarding
- Consult the retailer about appliance take back schemes

Don'ts

- Don't dump the discarded Electronic Equipment in the open or in any land fill site, as this will result in contamination of the soil and the ground water
- Don't dispose of the discarded Electronic Equipment in household bins or Municipal bins
- The product is not meant for re-sale to any unauthorized agencies/scrap dealers
- Don't keep any replaced spare part(s) from the product in an exposed area

Tips on economical use

- Always fill the appliance with the maximum amount of laundry for each programme.
- Wash normally soiled laundry without pretreating.
- For light and normal soiling in laundry, you can save energy and detergent.
- The selectable temperatures apply to the care labels on the textiles. The temperatures in the appliance may deviate from this so that you get the optimum mix of energy-saving and washing results.
- **Information about the energy consumption*:**
The display provides information about the relative energy consumption in the selected program.
The more indicator lights light up, the higher the program's consumption.
This enables you to compare the consumption levels of the different programs when choosing your program settings and to decide on an energy- and water-saving program setting for the selected program.
- **Low power mode:** If the appliance is not operated for a prolonged period (approx. 5 minutes), the display panel lighting goes out before the programme starts and after the programme has ended, ▷||| flashes. Select any button to activate the display backlighting.
Low power mode is not be activated when the programme is running.
- If the laundry will be dried in a dryer, select the spin speed according to the dryer manufacturer's instructions.

* depending on the model

Getting to know the appliance

Washing machine

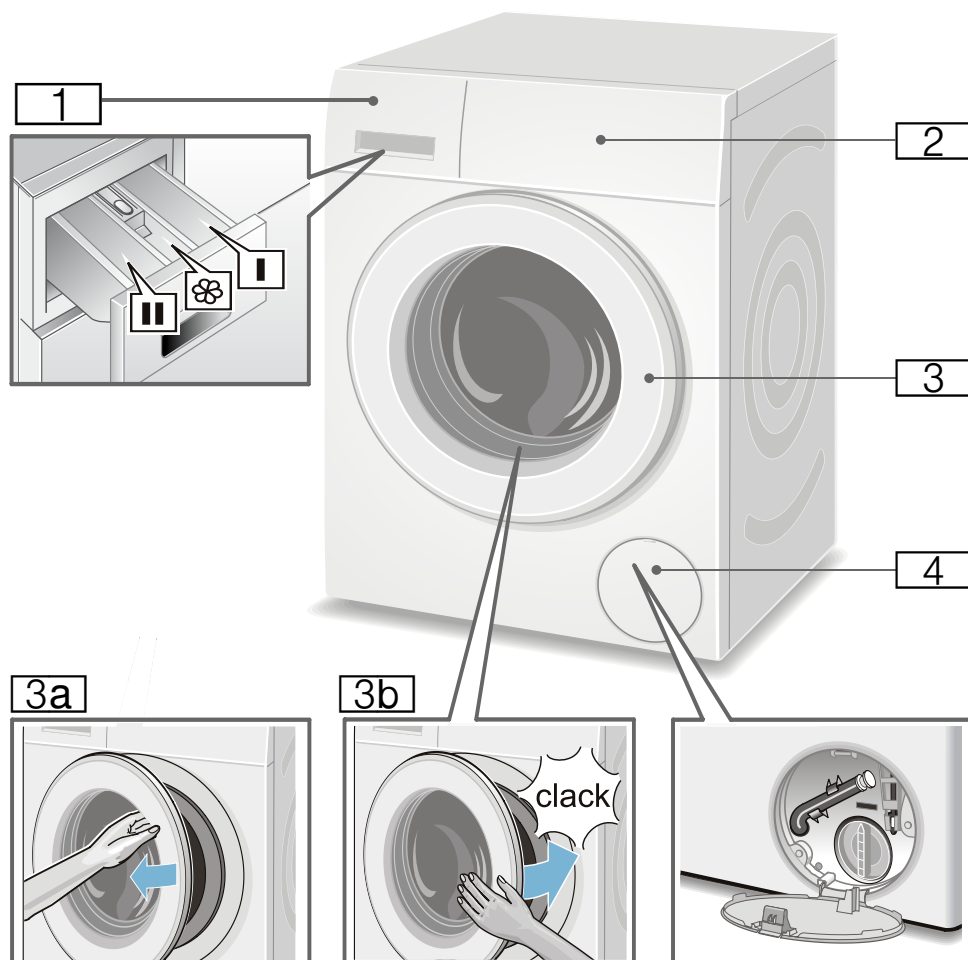

- 1 Detergent dispenser
- 2 Control panel
- 3 Door

- 3a Open the door
- 3b Close the door
- 4 Service flap

Control panel

You can find possible programme default settings and additional programme settings in the overview; these differ depending on the model.

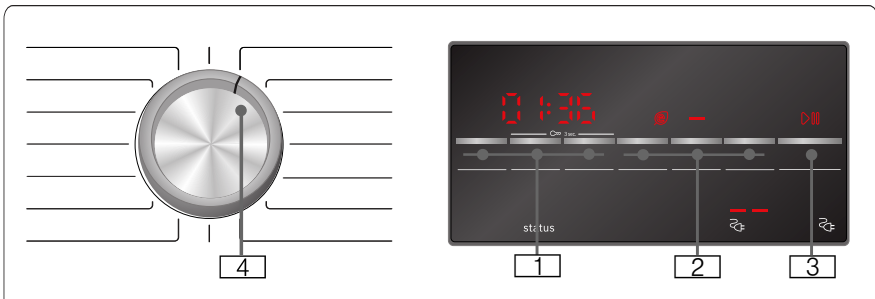
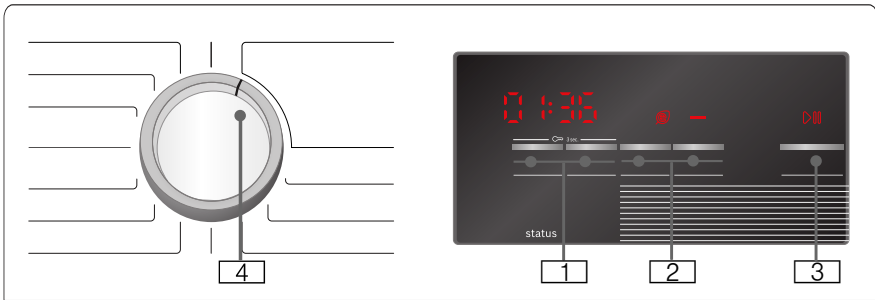

- 1 **Programme default settings** can be changed.
Overview of all programme default settings → *Page 13*
- 2 **additional programme settings** can be selected.
Overview of all additional programme settings → *Page 15*
- 3 **Start button** for starting, interrupting, (e.g. adding laundry) and cancelling a programme.
- 4 **Programme selector** for selecting the programme and for switching the washing machine on and off.

Display panel

In the table you can find possible settings and information in the display panel; these differ depending on the model.

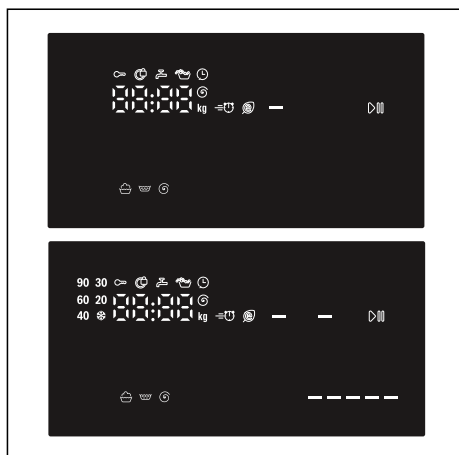

Settings for the selected programme		
☼ - 90*	Temperature in °C	Temperature
----, 0 - 1400*	Spin speed in rpm (revolutions per minute)	Maximum spin speed or ---- (Rinse stop = without final spin, washing remains in the water after the last rinse)
1:30	Programme length	Depends on the programme selection in h:min (hours:minutes)
1 - 24	Finish in h (hours)	End of programme after ... Hours
8.0 kg*	Load in kg	Maximum load
* Depending on the model		

Status indicators for the programme progress (programme sequence)		
🧺, 🧺, 🕒, End		Wash, rinse, spin/drain, programme end.
🔒	Childproof lock	Lights up: The childproof lock is active. Flashes: The childproof lock is activated, and if the programme selector has been adjusted or the buttons have been pressed.
🔒	Door lock	Lights up: When the door can not be opened.
🚰	Tap	Lights up: Water pressure is too low. This extends the programme duration. Flashes: The tap has not been turned on or there is no water supply.
🧼	Overdosage	On if too much foam detected, one additional rinse cycle switched on.
---- 🧺*		Power consumption.
* Depending on the model		



Laundry

Preparing the laundry

Caution!

Damage to the appliance/fabrics

Foreign objects (e.g. coins, paper clips, needles, nails) may damage the laundry or components in the appliance.

Therefore, note the following tips when preparing your laundry:

- Empty any pockets.

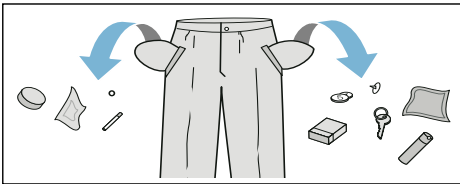

- Check for metal items (paper clips, etc.) and remove them.
- Wash delicates in a laundry bag (tights, underwired bras, etc.).

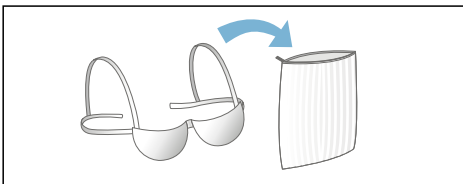

- Remove curtain fittings or place curtains in a laundry bag.
- Close any zips, button up any cover buttons.
- Brush sand out of pockets and collars.

Sorting laundry

Sort your laundry according to the care instructions and manufacturer's information on the care labels:

- Type of fabric/fibre
- Colour

Note: Laundry can discolour or not be cleaned correctly. Wash white and coloured laundry separately. Wash new bright fabrics separately the first time you wash them.

- Soiling

Wash laundry with the same level of soiling together.

You can find examples of levels of soiling on

- **Light:** Do not pretreat, select the  **SpeedPerfect** setting if necessary

- **Normal**

- **Heavy:** Load less laundry, pretreat the laundry if necessary.

- **Stains:** Remove/pretreat stains while they are fresh. First, dab the stain with soapy water/do not rub. Then wash the items of laundry with the appropriate programme. Stubborn/dried-in stains can sometimes only be removed with several washes.

- Symbols on the care labels

The numbers in the symbols indicate the maximum washing temperature which may be used.

- : Suitable for a normal washing process;



e.g.  **Cottons** programme.

- : A gentle washing process is required;

e.g.  **Easy Care//Synthetics** programme.

- : An especially gentle washing process is required;

e.g.  **Delicates/Silk//Delicate/Silk** programme.

- : Suitable for washing by hand; e.g.  **Wool** programme.

- : Do not wash the laundry in the machine.

Starching

Note: Laundry must not be treated with fabric softener.

Starching is possible in all wash programmes if liquid starch is used. Starching with liquid starch is possible in programs such as Rinse and Cottons

Dyeing/bleaching

Dye should only be used in normal household quantities. Salt may damage stainless steel. Always follow the dye manufacturer's instructions.

Do **not** use the washing machine to bleach clothes.

Soak

((☞))

Before the main wash cycle starts, the washing remains for longer in the water to partially dissolve intensive soiling.

Notes

- Put detergent in dispenser **I** before starting the appliance.
- Load laundry of the same colour.
- If your appliance does not have this additional programme setting, you can soak as follows:
 1. Put detergent in dispenser **II** before starting the appliance.
 2. Select the ☞ **Cottons 40 °C** programme and the ▷ button.
 3. Select the ▷ button after approx. 10 minutes. The laundry remains in the soaking solution.
 4. Leave the laundry to soak for as long as required, then either select the ▷ button again to continue the programme or change the programme.

Detergent

Correct selection of detergent

The care label is crucial to ensure correct detergent selection, temperature and laundry treatment.

- **Standard detergent with optical brighteners**
suitable for heat-resistant white washing made from linen or cotton
Programme: ☞ Cottons/
cold – max. 90 °C
- **Detergent for colours without bleach or optical brighteners**
suitable for coloured washing made from linen or cotton
Programme: ☞ Cottons/
cold – max. 60 °C
- **Detergent for colours/delicates without optical brighteners**
suitable for coloured laundry made from easy-care fibres, synthetic fibres
Programme: ☞ Easy Care//
Synthetics/
cold – max. 60 °C
- **Detergent for delicates**
suitable for delicate, fine fabrics, silk or viscose
Programme: ☞ Delicates/Silk//
Delicate/Silk/
cold – max. 40 °C
- **Detergent for woollens**
suitable for woollen fabrics
Programme: ☞ Wool/ cold – max. 40 °C

Saving energy and detergent

For light and normal soiling, you can save energy (lower washing temperature) and detergent.

Saving	Soiling/note
<p>Reduced temperature and detergent quantity as per the recommended dosage</p> 	<p>Light No visible dirt or stains. Clothing has taken on some body odour, e.g.:</p> <ul style="list-style-type: none"> ■ Light summer/sports clothing (worn for a few hours) ■ T-shirts, shirts, blouses (worn for up to one day) ■ Guest bed linen and hand towels (used for one day) <p>Normal Visible dirt or a few light stains, e.g.:</p> <ul style="list-style-type: none"> ■ T-shirts, shirts, blouses (sweat soaked, worn a few times) ■ Towels, bedding (used for up to one week)
<p>Temperature as per the care label and detergent quantity as per the recommended dosage for heavy soiling</p>	<p>Heavy Dirt and/or stains clearly visible, e.g. tea towels, baby items, work clothing</p>

Note: When measuring the amount of all detergents/additives/care products and cleaning agents, please always check the manufacturer's instructions and information.
 → "Measure and add detergent and care products" on page 17

P+ Programme default settings

Note: You can find possible programme default settings in the overview; these differ depending on the model.

The programme default settings for all programmes are preset at the factory and are displayed in the display panel after the programme is selected.

Temperature

(Temp. °C)

Setting depending on the model

Depending on what stage the program is in, you can change the set temperature before and at the beginning of the program.

The maximum temperature that can be set depends on the program that has been selected.

Spin speed

(⊖ rpm//⊕ Spin Speed)

Depending on what stage the program is in, you can change the spin speed (in rpm; revolutions per minute) before and during the program.

Setting 0: The rinsing water is drained but there is no final spin. The laundry stays wet inside the drum, e.g. for items that should not be spun.

Setting - - - -: (Rinse Stop) = no final spin. The laundry stays in the water after the final rinse.

You can select "Rinse Stop" to prevent creasing if the laundry will not be taken out of the washing machine immediately after the program has ended.

To continue/end the program

→ *Page 20*

The maximum speed that can be set depends on the model and program that has been selected.

Finish in time

(⌚ Ready in//⌚ Finished in)

Before starting the program, you can preselect the program end ("Ready in" time) in hourly increments (h = hour) up to a maximum of 24 hours.

To do this:

1. Select a program.
The program duration is displayed for the selected program, e.g. **2:30** (hours:minutes).
2. Press the (⌚ **Ready in**//⌚ **Finished in**) button repeatedly until the required number of hours is displayed.
3. Press the ▷||| button.
The door will be locked.
The selected number of hours (e.g. **8 h**) is shown in the display panel and counts down until the wash program starts. The duration of the program is then displayed.

During the timer count-down, you can change the preselected number of hours as follows:

1. Press the ▷||| button.
2. Use the (⌚ **Ready in**//⌚ **Finished in**) button to change the number of hours.
3. Press the ▷||| button.

During the timer count-down, you can add or remove laundry as required:

1. Press the ▷||| button.
2. Open the door and add or remove laundry.
3. Close the door.
4. Press the ▷||| button.

Note: The length of the program is automatically adjusted when the program is running.

Certain factors can affect the program length, e.g.:

- Program settings,
- Detergent dosage (additional rinse cycles if required due to foaming),
- Load size/type of textiles (longer washing for higher load and for textiles which absorb more water),
- Imbalances (e. g. due to fitted sheets) are offset with several start-ups of spin cycles,
- Fluctuations in power supply,
- Water pressure (infeeding speed).



P+ Additional programme settings



Note: You can find possible additional programme settings in the overview; these differ depending on the model.

SpeedPerfect/EcoPerfect

( )

Button with two possible settings for adapting the selected program:

-  **SpeedPerfect**
Washing in a shorter time while achieving a washing result that is consistent with, but uses more energy than, the selected program, without the SpeedPerfect/EcoPerfect setting.
Note: Do not exceed the maximum load.
-  **EcoPerfect**
Energy-optimised washing by reducing the temperature while achieving a washing result that is consistent with the selected program, without the SpeedPerfect/EcoPerfect setting.

Press the button to do this. First of all, you can select the  **SpeedPerfect** setting. If you press the button again, the  **EcoPerfect** setting is active. The respective symbol is shown in the display when the setting is activated.



If you press the button again, no setting is active.

Rinse&Water Plus

( Rinse Plus// Extra Water// Water Plus// Water plus)

Increased water level and additional rinse cycle, extended washing time. For areas with very soft water or for further enhancing the spin result.

Easy Iron

(( Easy iron// Easy Iron))

Special spin sequence with subsequent fluffing. Gentle final spin – residual moisture in the laundry slightly increased.



Operating the appliance

Note: **Install** and **connect** washing machine properly.

Before the 1st wash → Page 37

Preparing the washing machine

Notes

- Never switch on a damaged washing machine!
 - Inform customer service!
1. Connect the mains plug.
 2. Turn on the tap.
 3. Open the door.
 4. Check that the drum is completely emptied. Empty if necessary.

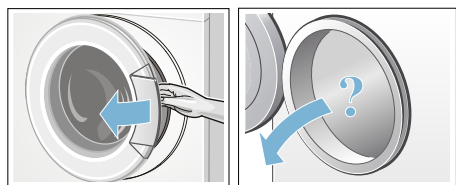

Select programme/switch on the appliance

Note: If you have activated the childproof lock, you must first deactivate it before you can set a program.

Use the program selector to select the required program. Can be rotated in either direction.

The appliance is switched on.

The **program default settings** for the selected program appear in the display panel:

- Temperature*,
- Spin speed*,
- The maximum load and the duration of the program (alternately),
- Energy consumption*.

*depending on the model

Change the programme default settings

You can use the default settings or change them.

To do this, repeatedly select the corresponding button until the required setting is displayed.

The settings are activated without needing to be confirmed.

They are not saved when the appliance is switched off.

→ "Programme default settings" on page 13

Overview of programmes → Supplementary sheet for the operating and installation instructions.

Select additional programme settings

By selecting additional settings, you can better adapt the washing process to your items of laundry.

The settings can be selected or deselected depending on the programme progress.

The indicator lamp for the button lights up if a setting is active.

The settings are not saved when the appliance is switched off.

→ "Additional programme settings" on page 15

Overview of programmes → Supplementary sheet for the operating and installation instructions.

Placing laundry into the drum

Warning

Danger of death!

Items of laundry pretreated with cleaning agents that contain solvents, e.g. stain remover/cleaning solvent, may cause an explosion after being loaded into the washing machine. Hand-rinse items of laundry thoroughly beforehand.

Notes

- Mix items of laundry of varying sizes. Laundry items of different sizes distribute themselves better during the spin cycle. Individual items of laundry may lead to imbalances.
 - Observe the specified maximum load. Overfilling has a negative impact on the washing result and promotes creasing.
1. Place presorted items of laundry unfolded in the washing drum.
 2. Make sure that no items of laundry are trapped between the washing machine door and the rubber seal, and close the door.



The  button indicator lamp flashes to indicate that the washing program can be started. It is possible to change the settings.

→ "Dyeing/bleaching" on page 12

→ "Spin speed" on page 13

Measure and add detergent and care products

Caution!

Damage to the appliance

Cleaning agents and agents for pretreating laundry (e.g. stain removers, prewash sprays, etc.) may cause damage if they come into contact with the surfaces of the washing machine. Do not allow these agents to come into contact with the surfaces of the washing machine. If necessary, immediately wipe away spray residue and other residues/droplets with a damp cloth.

Measuring

Measure the detergent and care products according to:

- Water hardness; ask your water supply company
- The manufacturer's instructions on the packaging
- The amount of laundry
- Soiling

Filling

Warning

Eye/skin irritation!

Detergent and care products may spray out if the detergent drawer is opened while the machine is in operation. Open the drawer carefully.

Rinse eyes or skin thoroughly if they come into contact with detergent/care products.

If swallowed accidentally, seek medical advice.

Note: Dilute viscous fabric softener and fabric conditioner with water; this prevents blockages.

en Operating the appliance

Pour the detergent and care products into the appropriate compartments:

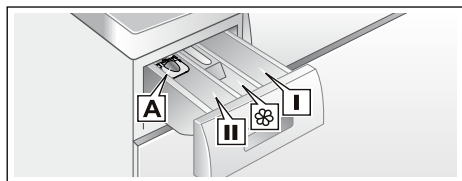

Measuring aid **A*** For liquid detergent
Compartment **II** Detergent for the

main wash, water softener, bleach, stain remover

Compartment  Fabric softener, starch

Do not exceed the **max.**

Compartment **I** Detergent for prewash

*depending on the model

1. Pull out the detergent drawer as far as possible.
2. Add detergent and/or care products.
3. Close the detergent drawer.

Measuring aid* for liquid detergent

*depending on the model

Position the measuring aid for measuring the correct amount of liquid detergent:

1. Pull out the detergent drawer. Press down the insert and fully remove the drawer.
2. Slide the measuring aid forwards, fold it down and click it into place.
3. Reinsert the drawer.

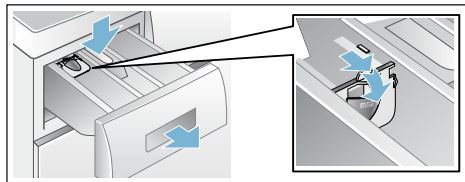

Note: Do not use the measuring aid for gel detergents and washing powder, or for programmes with prewash or when "Finished in" time is selected.

For models without a measuring aid, pour the liquid detergent into the appropriate dispenser and place it in the drum.

Starting the programme

Press the  button. The indicator lamp lights up and the program starts.

The display panel shows the Ready in time while the program is running or the program duration and the program progress symbols once the wash cycle has started.

Note: Foam detection

If the  symbol also lights up in the display panel, the washing machine has detected too much foam during the wash cycle and automatically activated additional rinse cycles to remove the foam.

Add less detergent to the next wash cycle with the same load.

If you want to lock the program to prevent it from being inadvertently adjusted, you can select the childproof lock as follows.

Childproof lock

(∞ 3 sec.)

You can lock the washing machine to prevent the functions you have set from being changed inadvertently. To do this, **activate the childproof lock when the program has started.**

To **activate/deactivate**, press and hold the (⊖ rpm//⊕ **Spin Speed**) and (⌚ **Ready in**//⌚ **Finished in**) buttons at the same time after the washing program has started. Keep pressing the two buttons for approx. three seconds. The ∞ symbol appears in the display panel.

- ∞ lights up: The childproof lock is active.
- ∞ flashes: The childproof lock is active and the program selector has been adjusted. To deactivate the childproof lock, reset the program selector to the initial program. The symbol lights up again.

Note: To avoid the program to terminate, do not turn the program selector beyond the Off position.

Note: The childproof lock remains active after the program has ended and the appliance is switched off. You must always deactivate the childproof lock if you want to start a new program.

Adding/removing laundry

Following the start of the program, you can add or remove laundry as required.

Press the ▷||| button to do this.

The ▷||| button indicator lamp flashes and the machine checks whether it is possible to add laundry.

If the following appears in the display panel:

- The ⊕ symbol disappears: adding laundry is possible.
- The ⊕ symbol lights up: it is not possible to add laundry.

To continue the program, press the button ▷|||. The program continues automatically.

Notes

- Do not leave the door open for too long when adding laundry as water from the laundry may leak out.
- For safety reasons, the door remains locked when the water level or temperature is high, or while the drum is turning, and it is not possible to add laundry during this time.
- The load display is not active during reloading.

Changing the programme

1. Press the ▷||| button.
2. Select another program.
3. Press the ▷||| button. The new program starts from the beginning.

Cancel the programme

For programs at high temperature:

1. Press the ▷ button.
2. To cool down laundry: Select **Rinse/Freshen up//Rinse**.
3. Press the ▷ button.

For programs at low temperature:

1. Press the ▷ button.
2. Select **Spin/Drain**.
3. Press the ▷ button.

Programme end during rinse hold

---⊙ appears in the display panel and the indicator lamp of the ▷ button flashes.

Continue the program by:

- Pressing the ▷ button (the laundry will be drained with the default spin speed setting*) or
- Selecting a spin speed or set the program selector to **Spin/Drain** and then pressing the ▷ button.

* depending on the chosen program -> Overview of programmes

Programme end

End appears in the display panel and the indicator lamp of the ▷ button is off.

Removing laundry/switching off the appliance

1. Open the washing machine door and remove the laundry.
2. Turn the programme selector to **Off**. Appliance is switched off.
3. Turn off the tap.
Not required for Aqua-Stop models. Contents of package

Notes

- Do not leave any items of laundry in the drum. They may shrink in the next wash or discolour another item.
- Remove any foreign objects from the drum and the rubber seal – risk of rusting.

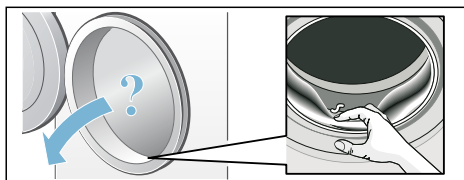

- Leave the washing machine door and detergent drawer open so that any residual water can dry away.
- Always remove the washing.
- Always wait until the programme ends, as the appliance could still be locked. Switch the appliance on and wait for the unlocking device.
- If at the end of the programme the display has gone out, the energy saving mode is active. To activate, select any button.

Setting the signal

You can change the following settings:

- The volume for the information signals (e.g. at the end of the program) and/or
- The volume of the audible button signals.

You will need to activate the setting mode in order to change these settings.

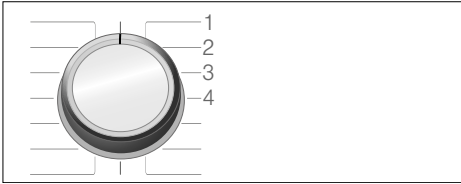



1/2/3/... positions on the program selector

Activate setting mode:

1. Set the program selector to position 1. The washing machine is switched on.
2. Press the  button and, at the same time, turn the program selector clockwise to position 2. Release the button.

The setting mode is activated and the preset volume for the information signals appears in the display panel (e.g. at the end of the program).

Changing the volume

Use the  **Ready in** //  **Finished in** button to change the following settings at the corresponding program selector positions:

- 2: The volume of the information signals and/or
- 3: The volume of the button signals.



0 = off, 1 = quiet,
2 = medium, 3 = loud,
4 = very loud

Exiting setting mode

You can now end the process and set the program selector to the **Off** position. The settings are saved.

Sensors

Automatic load sensing

The automatic load-sensing function perfectly adapts the water consumption to each programme depending on the type of fabric and the load.

Unbalanced load detection system

The automatic unbalanced load detection system detects imbalances and ensures even distribution of the laundry by repeatedly starting and stopping the drum spinning.

If the laundry is extremely unevenly distributed, the spin speed is reduced or the spin cycle is not performed for safety reasons.

Note: Place large and small items of laundry evenly in the drum.
→ *"Faults and what to do about them"* on page 25



Cleaning and maintenance



Warning

Danger of death!

There is a risk of electric shock if you touch live components. Switch off the appliance and unplug the mains plug.



Warning

Risk of poisoning!

Toxic vapours can be produced by cleaning agents that contain solvents, e.g. cleaning solvent. Do not use cleaning agents that contain solvents.

Caution!

Damage to the appliance

Cleaning agents that contain solvents, e.g. cleaning solvent, can damage surfaces and components in the machine. Do not use cleaning agents that contain solvents.

Machine housing/control panel

- Wipe the housing and the control panel with a soft, damp cloth.
- Remove the detergent residue immediately.
- Do not clean with a water jet.

Drum

Use chlorine-free cleaning agents, do not use steel wool.

If there are odours in the washing machine, or to clean the drum, run the

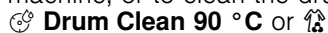

Drum Clean 90 °C or **Cottons 90 °C** program without laundry. Add washing

powder. → "Faults and what to do about them" on page 27

Descaling

Descaling should not be necessary if the detergent is measured out correctly. However, if it is required, follow the manufacturer's instructions for the descaling agent. Suitable descalers can be obtained via our website or from our after-sales service. → Page 29

Detergent drawer and housing

If the detergent drawer contains detergent or fabric softener residues:

1. Pull out the detergent drawer. Press down the insert and fully remove the drawer.
2. To remove the insert: Push the insert upwards from below with your finger.

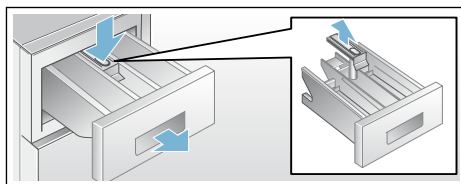

3. Clean the detergent dispenser tray and insert with water and a brush, and dry it. Clean the inside of the housing as well.
4. Fit the insert and lock it in place (push the cylinder onto the guide pin).
5. Push in the detergent drawer.

Note: Leave the detergent drawer open so that any residual water can evaporate.

Detergent solution pump blocked



Warning Risk of scalding!

When you wash at high temperatures, the water gets very hot. If you come into contact with the hot water, you may be scalded.

Allow the water to cool down.

After the water has cooled down:

1. Turn off the water tap so that no more water can flow in and has to be drained via the drain pump.
2. Switch off the appliance.
3. Disconnect the mains plug.
4. Open and remove the service flap.

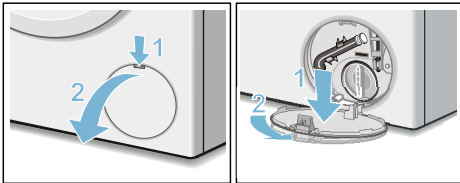

5. Take the drain hose out of the retainer. Remove the sealing cap, allow the water to flow out into a suitable container. Replace the sealing cap and place the drainage hose in the retainer.

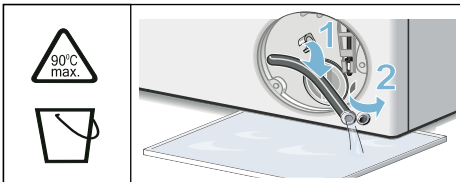

6. Carefully unscrew the pump cover, residual water may leak out. Clean the interior, pump cover thread and pump housing. The impeller in the detergent solution pump must be able to rotate. Refit the pump cover and screw it on tightly. The handle must be in a vertical position.

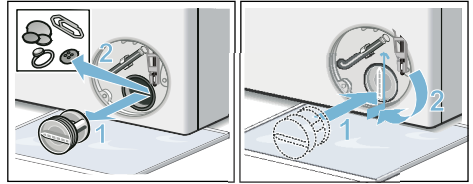

7. Place the service flap back on, lock it into place, and close it.

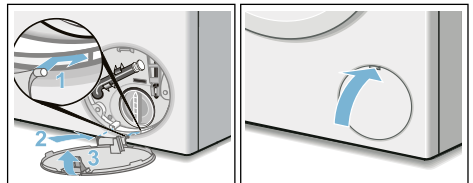

Note: To prevent unused detergent from flowing straight into the drain during the next wash, pour 1 litre of water (without detergent) into compartment **II** and start the **Spin/Drain** programme. Do the next wash as usual.

The drain hose at the siphon is blocked

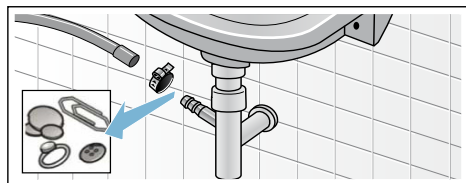

1. Switch off the appliance.
2. Disconnect the mains plug.
3. Loosen the hose clamp. Carefully remove the drain hose; residual water may leak out.
4. Clean the drain hose and siphon connecting piece.



5. Reattach the drain hose and secure the connection using the hose clamp.

Filter in the water supply is blocked

First, reduce the water pressure in the supply hose:

1. Turn off the tap.
2. Select any program (except  Spin/Drain ).
3. Press the  button. Allow the program to run for approximately 40 seconds.
4. Turn the program selector to off position.
5. Pull out the mains plug.
6. Clean the filter on the tap: Disconnect the hose from the tap. Clean the filter with a small brush.

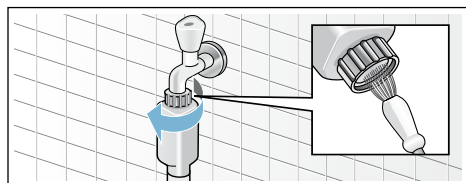

7. For standard and Aqua-Secure models, clean the filter on the rear of the appliance: Remove the hose from the rear of the appliance. Use pliers to remove the filter and then clean it.

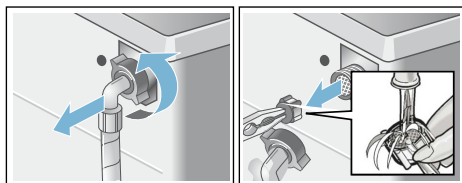

8. Insert the filter, connect the hose and check for leaks.

Faults and what to do about them

Emergency release

(depending on the model)

e.g. in the event of a power outage

Note: The programme will continue running when the power supply has been restored.

Warning

Risk of scalding!

When you are washing at high temperatures, there is a risk of scalding if you come into contact with detergent solution and laundry.

If possible, leave it to cool down.

Warning

Risk of injury!

You may injure your hands if you reach into the drum while it is turning.

Do not reach into the drum when it is turning. Wait until the drum has stopped turning.

Caution!

Water damage



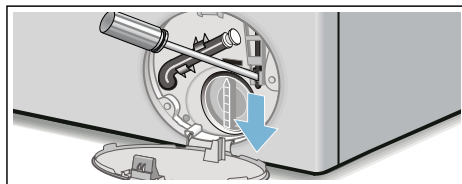

Any escaping water may cause water damage. Do not open the washing machine door if water can be seen through the glass.

If the laundry has to be removed, the washing machine door can be opened as follows:







1. Switch off the appliance.
2. Disconnect the mains plug.
3. Drain the water. → *Page 23*
4. Pull the emergency release downwards with a tool and release. The washing machine door can now be opened.









Information on the display panel

Display	Cause/Remedy
	<ul style="list-style-type: none"> ■ Flashes fast + warning signal: The door was opened and the water level is too high. Close the door, continue the programme with  button or select  Spin/Drain  programme. ■ Flashes slowly: The door lock temperature is too high to open the door. Wait approx. 30 seconds until the door lock temperature cools down.
	<ul style="list-style-type: none"> ■ Flashes (no water supply): Tap turned on? Water inlet filter blocked? Clean the water inlet filter. If an additional water filter has been installed (depending on the model), check for contaminants and clean if required → separate installation and cleaning instruction for water filter. Water hose kinked or blocked? ■ Lights up (low water pressure): For information only. This will not affect the programme progress. The programme duration is extended.
E:18	Drain pump blocked; clean the drain pump. Clean the drainage hose on the siphon.
E:32	Alternating display with End when programme is finished: unbalance problem, spinning phase is aborted.
:	<ul style="list-style-type: none"> ■ Flashes fast: For information only. Low line voltage is detected. The program duration time might be extended. ■ Flashes slowly: For information only. Low line voltage is detected during program running. The program duration time might be extended.
Other displays	Switch off the appliance, wait for five seconds and then switch it on again. If the display appears again, call customer services.

Faults and what to do about them

Faults	Cause/Remedy
Water is leaking from the machine.	<ul style="list-style-type: none"> ■ Attach the drain hose correctly or replace it. ■ Tighten the screw connection of the drain hose.
The machine is not filling with water.	<ul style="list-style-type: none"> ■ Have you pressed the  button? ■ Is the tap turned on?
Detergent is not being dispensed.	<ul style="list-style-type: none"> ■ Could the filter be clogged? Clean the filter → <i>Page 24</i> <p>Note: If an additional water filter has been installed (depending on the model), check for contaminants and clean if required → separate installation and cleaning instruction for water filter.</p> <ul style="list-style-type: none"> ■ Is the supply hose kinked or trapped?
The door cannot be opened.	<ul style="list-style-type: none"> ■ The safety function is activated. Stop the program? ■ Is the  childproof lock activated? Deactivate. ■ Is “---” selected (Rinse Stop = no final drain)? ■ Can the door only be opened by the emergency release?
The program will not start.	<ul style="list-style-type: none"> ■ Have you pressed the  or ( Ready in/ Finished in) button? ■ Is the door closed? ■ Is the  childproof lock activated? Deactivate.
The drum briefly jerks or judders after the program has started.	Not a fault – the internal motor test may cause the drum to jerk or judder briefly when the wash program starts.
The water is not draining.	<ul style="list-style-type: none"> ■ Is “---” selected (Rinse Stop = no final drain)? ■ Clean the drain pump → <i>Page 23</i> ■ Clean the drain pipe and/or the drain hose.
Water is not visible in the drum.	Not a fault – the water is below the visible area.
The spin result is not satisfactory. Laundry is wet/too damp.	<ul style="list-style-type: none"> ■ Not a fault – the unbalanced load detection system has interrupted the spin cycle because the laundry is unevenly distributed. Distribute small and large items of laundry evenly in the drum. ■ Anti-crease (depending on the model) selected? ■ Is the selected speed too low?
The spin cycle runs several times.	Not a fault – the unbalanced load detection system is adjusting an imbalance.
The program is taking longer than usual.	<ul style="list-style-type: none"> ■ Not a fault – the unbalanced load detection system is adjusting an imbalance by repeatedly distributing the laundry. ■ Not a fault – the foam detection is system active – a rinse cycle has been switched on.
The length of the program changes during the wash cycle.	Not a fault – the program sequence is optimised for the specific washing process. This may change the length of the program shown in the display panel.
Residual water in the care-product compartment  .	<ul style="list-style-type: none"> ■ Not a fault – the effect of the care product is not affected. ■ Clean the insert if necessary.

Faults	Cause/Remedy
Odours in the washing machine.	<p>Depending on the model, run the  Drum Clean 90 °C or  Cottons 90 °C program without laundry.</p> <p>Add washing powder or a detergent containing bleach.</p> <p>Note: To prevent foaming, only use half the amount of detergent recommended by the detergent manufacturer. Do not use detergents designed for wool or delicates.</p>
The  symbol lights up in the display panel. Foam may also be leaking from the detergent drawer.	<p>Have you used too much detergent?</p> <p>Mix one tablespoon of fabric softener with 1/2 litre of water and pour it into compartment II (not suitable for outdoor clothing, sportswear or items stuffed with down).</p> <p>Use less detergent in the next wash cycle.</p>
Loud noises, vibrations and machine "movement" during the spin cycle.	<ul style="list-style-type: none"> ■ Is the appliance aligned? Align the appliance → <i>Page 36</i> ■ Are the appliance's feet fixed? Secure the appliance's feet → <i>Page 36</i> ■ Have the transport braces been removed? Remove the transport braces → <i>Page 33</i>
The display panel/indicator lights do not work while the appliance is running.	<ul style="list-style-type: none"> ■ Has there been a power failure? ■ Have the fuses blown? Reset/replace the fuses. ■ If the fault occurs repeatedly, call customer services.
There is detergent residue on the laundry.	<ul style="list-style-type: none"> ■ Some phosphate-free detergents contain water-insoluble residue. ■ Select  Rinse/Freshen up//Rinse or brush the laundry after washing.
The  symbol lights up in the display in pause mode.	<ul style="list-style-type: none"> ■ Door is locked due to safety reasons (water level and/or temperature are too high). It is not possible to add laundry. Close the door immediately, if necessary. ■ Press the  button to continue the program.
<p>If you cannot rectify a fault yourself (after switching the machine off and on again) or a repair is required:</p> <ul style="list-style-type: none"> ■ Switch off the appliance and pull out the mains plug. ■ Turn off the tap and call customer services. 	



After-sales service

If you cannot correct the fault yourself → "*Faults and what to do about them*" on page 25 please contact our after-sales service. → Back page

We will always find an appropriate solution in order to avoid unnecessary visits by engineers.

Please give the after-sales service the product number (E no.) and the production number (FD) of the appliance.

E-Nr. _____	FD _____
Product number	Production number

You can find this information:

- on the inside of the washing machine door*
- in the opened service flap*
- on the rear of the appliance*

*depending on the model

Trust the expertise of the manufacturer.

Contact us for assistance. By doing so, you will ensure that the repairs are carried out by trained service personnel using genuine spare parts.



Technical information

Technical data

Dimensions:

848 x 598 x 590 mm
(height x width x depth)

Weight:

72 kg

Mains connection:

Nominal voltage 220-240 V, 50Hz
Minimum installation protection
(⇌)10A

Nominal power 1900-2300W

Water pressure:

0.1–1MPa (1–10 bar)

Information for test institute

Items

Pre-treatment of new appliance

According to standard

Washing programme

Testing instructions

Age of test loads

Loading Procedure

No. of Layers

External circle

Layer1

Layer2

Layer3

Layer4

Layer5

Instruction

Run two empty runs of 4 Cottons 90 °C with 1400 rpm: The 1st run with 50g detergent and 8g anti sudsing agent, the 2nd run without detergent and sudsing agent.

AS NZS 2040.1-2005

AS NZS 2040.2-2005

AS NZ 6400-2016

Cottons 60 °C + EcoPerfect , 8 kg(WAP28481AU), 9kg(WAP28482AU)1400 rpm

The dosage of detergent: 12.5g/kg

The dosage of anti sudsing agent: 2g/kg

Add the dry powder detergent into main wash dispenser before start. After detergent is flushed in add the PBIS solution and anti-sudsing agent as soon as possible.

The average age of test load around 10~20 times is recommended to replicate normal use.

The items are loaded into the drum by circle first, then by layers according to the table and picture below evenly.

Items of garments

sheets, bath towels

Tablecloth

Shirts, T-shirts, Pillow cases

Shorts (all), Wash cloths (all),handkerchiefs (all)

Shirts, T-shirts, Pillow cases

Tablecloth

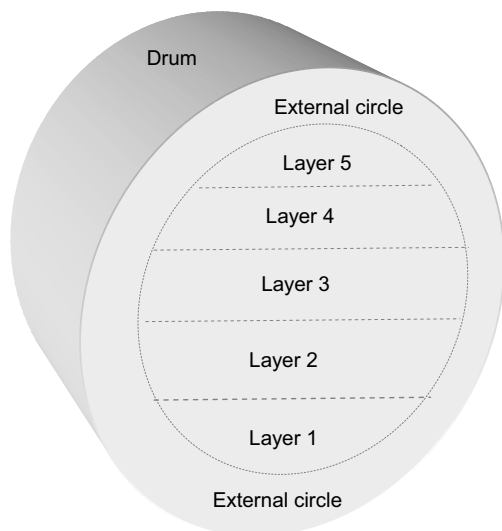



Positioning and connecting

Standard accessories

Note: Check the appliance for transport damage. Never use a damaged appliance. If you have any complaints, contact the dealer from whom you purchased the appliance or our Customer Service.

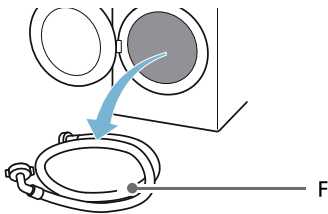
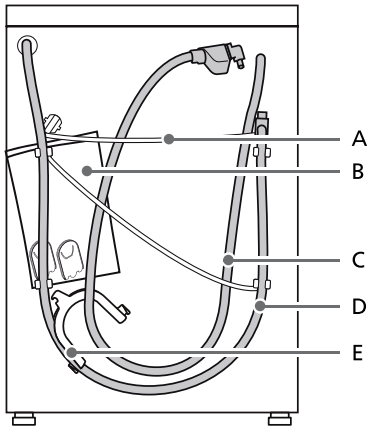

- A Mains lead
- B Bag:
 - Installation and operating instructions
 - Customer Service location directory*
 - Warranty*
 - Supplementary sheet for the installation and operating instructions*
 - Cover caps for openings after the transport braces have been removed
 - Home Connect Installation Guides*
- C Water inlet hose on aquaStop models
- D Water outlet hose
- E Elbow for securing the water outlet hose*
- F Cold water inlet hose on Standard/Aqua-Secure models
- * Depending on the model

In addition, a hose clamp (24 - 40 mm diameter, available from specialist retailers) is required to connect the water outlet hose to a siphon.

Useful tool

- Spirit level for aligning
- Wrench with:
 - WAF13 for loosening the transport braces and
 - WAF17 for aligning the appliance feet → *Page 36*

Safety instructions

Warning **Risk of injury!**

- The washing machine is very heavy. Be careful when lifting/transporting the washing machine.
- When the washing machine is lifted by its protruding parts (e.g. the washing machine door), the components may break off and cause injuries.
Do not lift the washing machine by protruding parts.
- If the hose and mains cables are not routed properly, there is a risk of tripping and injury.
Lay hoses and cables in such a way that there is no risk of tripping.

Caution!

Damage to the appliance

Frozen hoses may rip/burst.
Do not install the washing machine in areas exposed to frost or outdoors.

Caution!

Water damage

The connection points for the water supply hose and water drain hose are under high water pressure. To prevent leaks and water damage, you must follow the instructions in this section.

Notes

- In addition to the safety information listed here, the local water and electricity supplier may have special requirements.
- If in doubt, have the appliance connected by a specialist.

Installation surface

Note: The washing machine must be aligned in a stable manner so that it does not move around.

- The installation surface must be firm and level.
- Soft floors/floor coverings are not suitable.

Installation on a base or a wooden joist floor

Caution!

Damage to the appliance

The appliance may "wander" and tip/topple from the base when spinning. The feet of the appliance must be secured with holding brackets.
Order no. WMZ 2200, WX 975600, CZ 110600, Z 7080X0.

Note: On wooden joist floors, install the appliance:

- In a corner, if possible,
- On a water-resistant wooden board (min. 30 mm thick) which is screwed tightly to the floor.

Installation on a platform with drawer*

Platform order no.: WMZ 20490, WZ 20490, WZ 20510, WZ 20520.

Installing the appliance in a kitchenette

Warning **Risk of death!**

There is a risk of electric shock if you touch live components.
Do not remove the appliance covering plate.

Notes

- Recess width of 60 cm required.
- Only install the washing machine underneath a continuous worktop that is securely connected to adjacent cabinets.

* Depending on the model

Removing the transport locks

Caution!

Damage to the appliance

- The machine is secured for transportation using transport locks. If the transport locks are not removed, the machine may become damaged when it is operated. Before using the appliance for the first time, make sure that you completely remove all four transport locks. Keep the locks in a safe place.
- To prevent transport damage from occurring if the appliance is moved at a later date, you must refit the transport locks before transporting the appliance.

Note: Keep the screws and sleeves in a safe place.

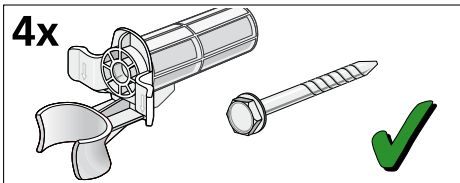

1. Take the hoses out of the holders.

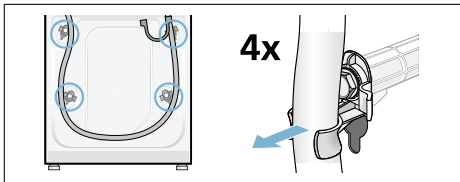

2. Unscrew and remove all four transport brace screws. Remove the sleeves. To do this, remove the mains cable from the holders.

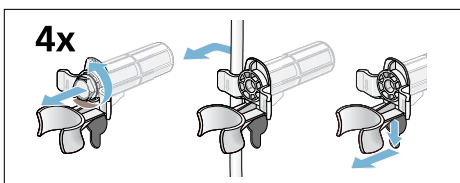

3. Fit the covers. Lock the covers firmly in place by applying pressure to the snap-in hooks.

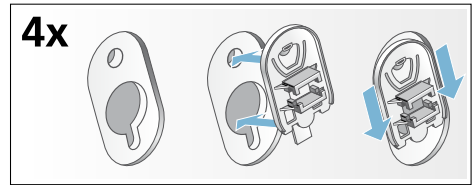

Hose and cable lengths

- Left-hand connection

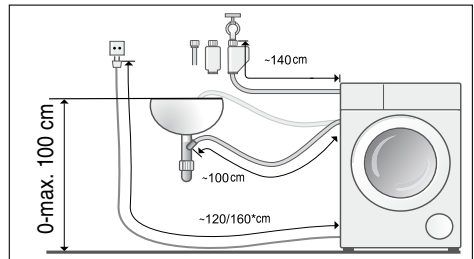

- Right-hand connection

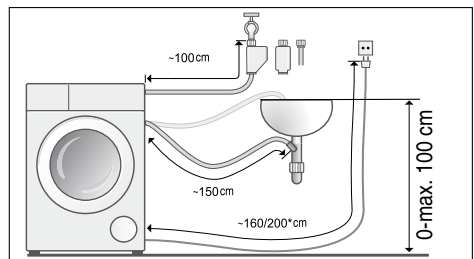

*depending on the model

Tip: If the supply hose is too short for your connection, you can order an extension from the after-sales service.

Water inlet

Warning **Risk of death!**

There is a risk of electric shock if you touch live components.

Observe the following when connecting the machine:

Notes

- Only operate the washing machine using cold mains water.
- Do not connect the machine to the mixer tap of an unpressurised hot-water boiler.
- Do not use a used supply hose. Only use the supply hose supplied with the machine or one that was purchased from an authorised retailer.
- Do not bend, squash, modify or cut through the water supply hose (otherwise its strength is no longer guaranteed).
- Only tighten the screw connections by hand. If the screw connections are tightened too much with a tool (pliers), the thread may be damaged.

Optimum water pressure in the supply network

At least 0.1 MPa (1 bar)

Maximum 1 MPa (10 bar)

When the tap is open, the water flow is at least 8 l/min.

If the water pressure is higher than this, a pressure-reducing valve must be installed.

Connection

1. Connect the water supply hose to the water tap ($\frac{3}{4}$ " = 26.4 mm) and to the appliance:
 - Model: **Standard**

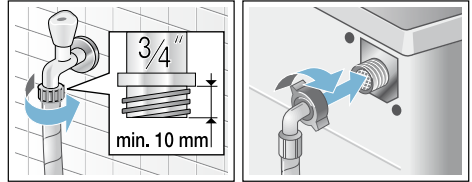

- Model: **Aqua-Secure**

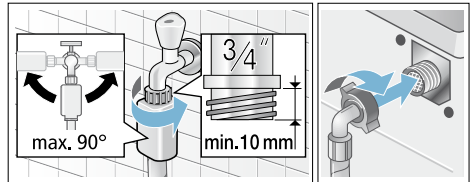

- Model: **Aqua-Stop**

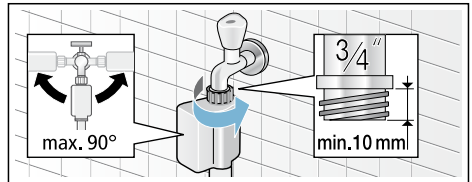

Tip: Connect also an external water filter (depending on the model) between water supply hose and tap. The filter filters dirt particles out of the water.

Water filter must be cleaned regularly to remove contaminants. This will prevent blockages. See also → separate installation and cleaning instruction for water filter.

2. Open the water tap carefully, checking the leak tightness of the connection points. The screw connection is under mains water pressure.

Water outlet

Caution! Water damage

When water is being pumped away, the outlet hose is under water pressure and may slip out of the wash basin or connection point.

Secure the outlet hose so that it cannot slip out.

Note: Do not kink the water drain hose or put strain on it lengthways.

You can lay the water drain hose as follows:

■ Outlet in a sink



Warning Risk of scalding!

When you are washing at high temperatures, there is a risk of scalding if you come into contact with hot water e.g. if hot water is being drained into a wash basin. Do not reach into the hot water.

Caution!

Damage to the appliance/fabrics

If the end of the drain hose is immersed in the drained water, water may be sucked back into the appliance and may damage the appliance/fabrics.

Make sure that:

- The plug does not block drainage from the sink.
- The end of the drain hose is not immersed in the drained water.
- The water drains away quickly enough.

Secure the outlet hose so that it cannot slip out.

Elbow available from after-sales service:

Individual part number 00655300

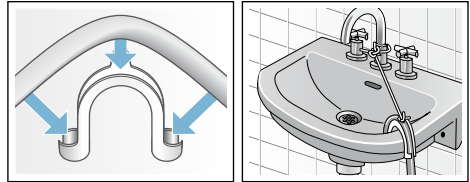

■ Drainage into a siphon

The connection point must be secured using a hose clamp with a diameter of 24-40 mm (available from specialist dealers).

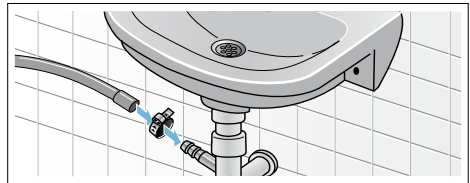

■ Outlet into a plastic pipe with rubber bushing or into a drainage pit

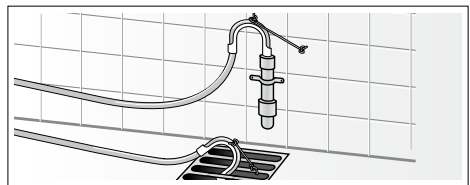

Levelling

Level the appliance using a spirit level. Incorrect levelling may result in intense noise, vibrations and "wandering".

1. Loosen the lock nuts using a wrench, by turning it in a clockwise direction.
2. Check the alignment of the washing machine with a spirit level, and adjust it if necessary. Change the height by turning the appliance feet. All four appliance feet must stand firmly on the ground.

3. Tighten the lock nut against the housing.
In doing so, hold the foot tight and do not adjust its height. The lock nuts on all four appliance feet must be screwed tightly against the housing.

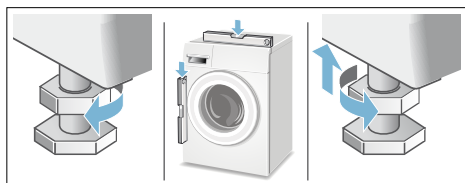

Electrical connection

Warning **Risk of death!**

There is a risk of electric shock if you touch live components.

- Never touch or hold the mains plug with wet hands.
- Only pull out the mains cable by the plug and never by the cable, as this could damage it.

Observe the following information and ensure that:

Notes

- The mains voltage and voltage indicated on the appliance (rating plate) are the same. The connected load and fuse required are specified on the rating plate.
- The appliance is only connected to an alternating current via a properly installed earthed socket.
- The mains plug fits the socket.
- The earthing system is properly installed.
- The mains cable is only replaced by a qualified electrician (if this is necessary). Replacement mains cables are available from the after-sales service.
- No multiple plugs/couplings or extension cables are used.
- If an earth-leakage circuit breaker is used, only a type which displays this symbol is used: . Only this symbol guarantees compliance with the currently applicable regulations.
- The mains plug can be accessed at all times.
- The mains cable is not bent, squashed, modified, cut through, or in contact with heat sources.

Before washing for the first time

The washing machine was thoroughly tested before leaving the factory. To remove any water that may be left over from the test, run the first wash cycle **without** any laundry.

Notes

- The washing machine **must be correctly installed and connected** → *Page 31*
 - Never use a damaged machine. Inform customer services.
1. Check the machine.
 2. Remove the protective film from the control panel.
 3. Connect the mains plug.
 4. Turn on the tap.
 5. Close the door (do not load any laundry).
 6. Depending on the model, run the 🌀 **Drum Clean 90 °C** or 🧺 **Cottons 90 °C** program. For AU variant, two cycles of 🧺 **Cottons 90 °C** programme without laundry are required to be run at initial setup, and this operation only needs to be completed once.
 7. Open the detergent drawer.
 8. Pour approximately 1 litre of water into compartment **II**.
 9. Pour standard detergent into compartment **II**.
Note: To prevent foaming, only use half the amount of detergent recommended by the detergent manufacturer. Do not use detergent designed for wool or delicates.
 10. Close the detergent drawer.
 11. Press the ▶🌀 button.
 12. When the program ends, switch off the appliance.

Your washing machine is now ready to use.

Transportation

e.g. when moving home

Preparatory work:

1. Turn off the water tap.
2. Reduce the water pressure in the supply hose.
Maintenance – filter in the water supply → *Page 24*
3. Disconnect the washing machine from the main plug.
4. Drain the remaining detergent solution.
Maintenance – detergent solution pump blocked → *Page 23*
5. Remove the hoses.

Installing the transport locks:

1. Remove the covers and keep them in a safe place.
Use a screwdriver if necessary.

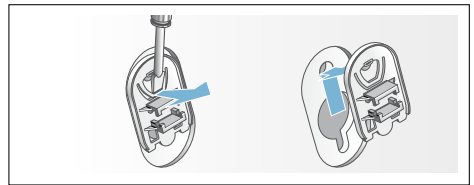

2. Insert all four sleeves.
Clip the mains cable securely in the holders. Insert and tighten the screws.

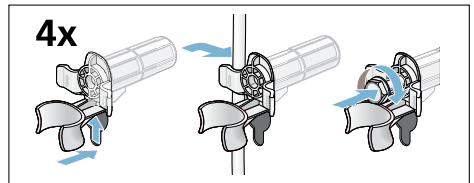

en Positioning and connecting

Before switching on the appliance again:

Notes

- The transport locks **must** be removed. → *"Removing the transport locks" on page 33*
- To prevent unused detergent from flowing straight into the drain during the next wash: Pour approx. 1 litre of water into compartment **II** and start the  **Spin/Drain**  program.



Thank you for buying a Bosch Home Appliance!

Register your new device on MyBosch now and profit directly from:

- **Expert tips & tricks for your appliance**
- **Warranty extension options**
- **Discounts for accessories & spare-parts**
- **Digital manual and all appliance data at hand**
- **Easy access to Bosch Home Appliances Service**

Free and easy registration – also on mobile phones:

www.bosch-home.com/welcome

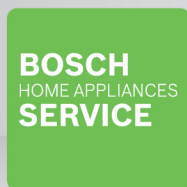

Looking for help? You'll find it here.

Expert advice for your Bosch home appliances, need help with problems or a repair from Bosch experts.

Find out everything about the many ways Bosch can support you:

www.bosch-home.com/service

Contact data of all countries are listed in the attached service directory.

Robert Bosch Hausgeräte GmbH

Carl-Wery-Straße 34

81739 München, GERMANY

www.bosch-home.com



9001408066 (9903)

en